

Lithium Iron Phosphate (LiFePO4) Battery Specification

SLAUMXLI84-12(12.8V84AH)

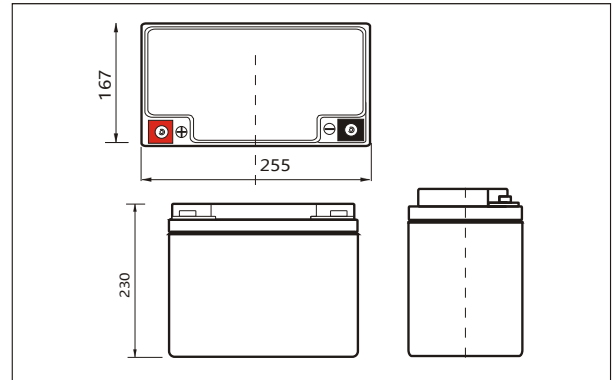

Outer dimensions (mm)



Specifications

Nominal Voltage	12.8V	
Rated capacity (20 hour rate)	84Ah	
Dimensions	Total Height	230 mm
	Height	230 mm
	Length	255 mm
	Width	167 mm
Weight Approx	10.2 Kg	
Terminal	M8	

Terminal Type (mm)

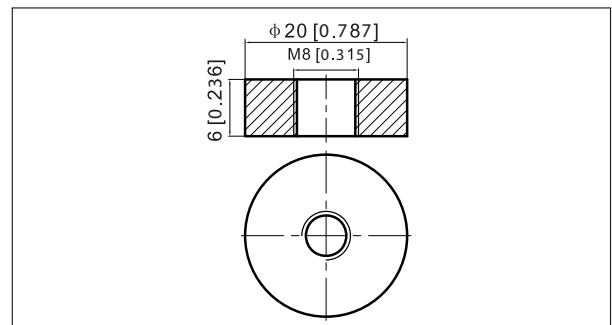

Characteristics

Capacity Retention	>80% at 28 days	
Cycle Life	>80% at 2000 Cycles	
1.5 hour discharge to 10.5V	3.00 A	
Internal Resistance	<20 mΩ	
Charge Characteristics	Charge Voltage	14.6±0.1V
	Charger Current	<80A
Discharge Characteristics	Max Continuous Current	80A
	Min Discharge Cut-off Voltage	10V
Temperature	Charge Temperature	0°C-45°C(32°F-113°F)
	Discharge Temperature	-20°C-60°C(-4°F-140°F)
	Storage Temperature	0°C-40°C(32°F-104°F)

Discharge Curves 25°C(77 °F)

